

Assembly Instruction

CALVI - 1055403

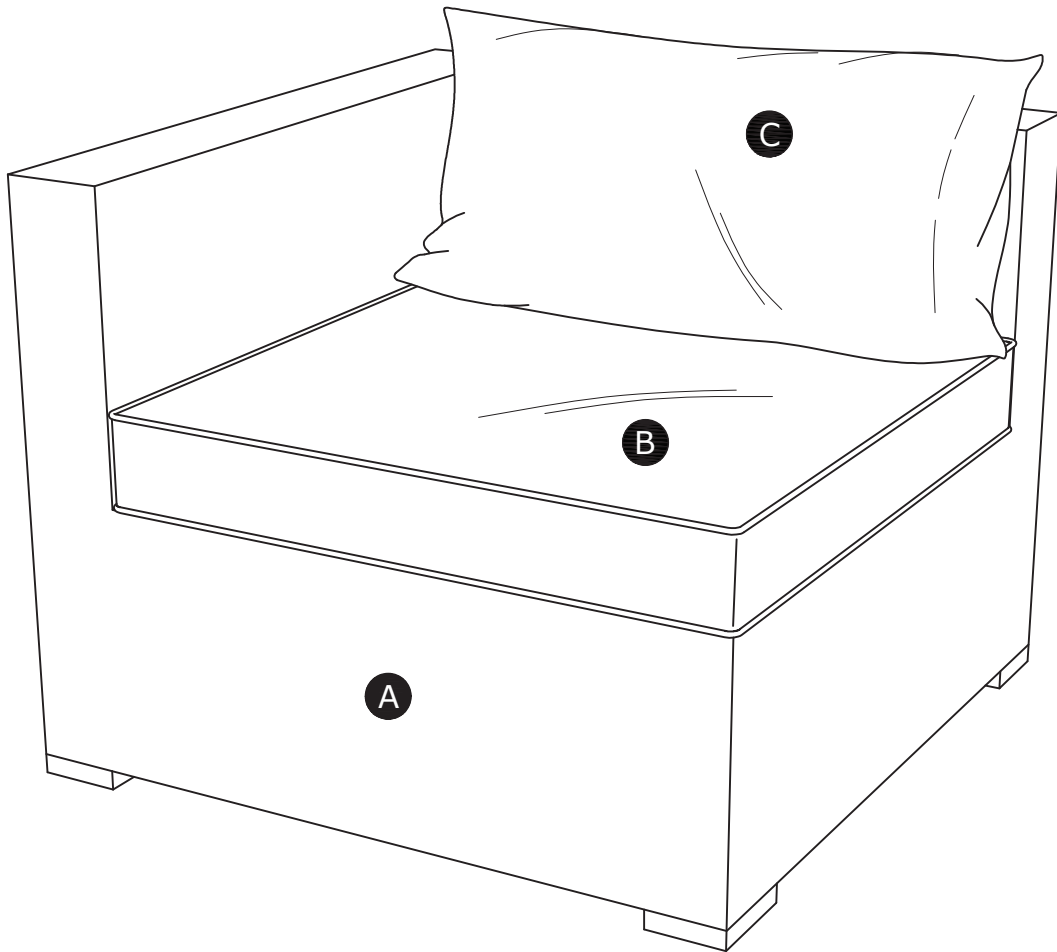

88 x 88 x 66 cm



2-Connect Aps, Lene Haus Vej 9,
DK-7430 Ikast, Denmark.
DK20036184

31-10-2019

ILVA

Kære kunde

Tillykke med dit nye køb.
Følg disse råd og få det bedste resultat, når du samler produktet.

- Læs vejledningen grundigt, før du går i gang
- Find hjælp, hvis I skal være to til at samle møblet
- Tjek at pakken indeholder alle dele på materialeoversigten
- Saml møblet på et blødt underlag, så du undgår ridser
- Følg vejledningen nøje
- Efterspænd møblet efter en måned
- Gem denne vejledning

Afsæt tid

Nogle møbler kan samles på få minutter. Andre – der f.eks. består af flere dele – kan tage over en time at samle. Afsæt god tid eller gør evt. arbejdet af flere omgange.

Mangler du enkeltdele, eller har du spørgsmål til samlevejledningen? Så kontakt kundeservice på ilva.dk

Venlig hilsen
ILVA

Dear Customer

Congratulations on your new purchase.
Follow this advice and get the best result when assembling the product.

- Read the instruction carefully before you start
- Get help, If two persons are required for assembly
- Make sure, you have all parts on the total material list
- Work on a soft, flat surface to avoid any damage to the finish
- Follow the assembly instruction
- Tighten the furniture joints after a month
- Keep the assembly instruction

Allocate time

Some furniture can be assembled in minutes. Others – e.g. products in several parts – can take more than an hour to finish. Make sure to allocate good time or divide up the work.

If any parts are missing or if you have questions for the assembly instruction, please contact customer support at ilva.dk

Best regards,
ILVA

Warning !!!

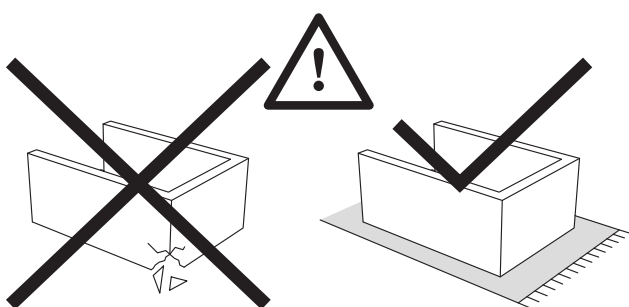

Total material list, hardware

1 x 1

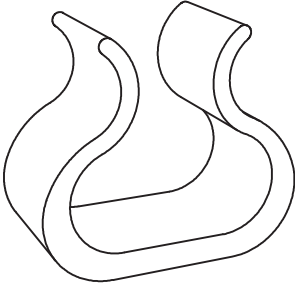

Total material list, furniture parts

A x 1

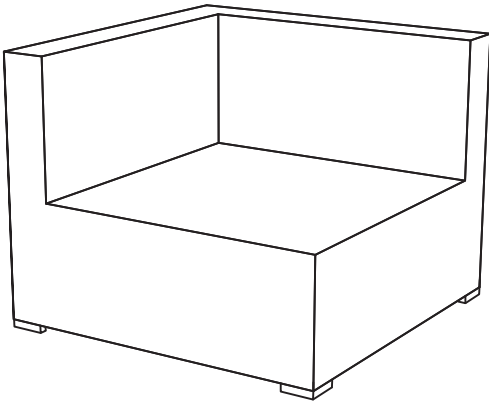

B x 1

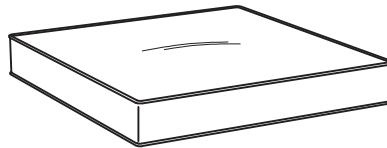

C x 1



Material list, 1

A x 1

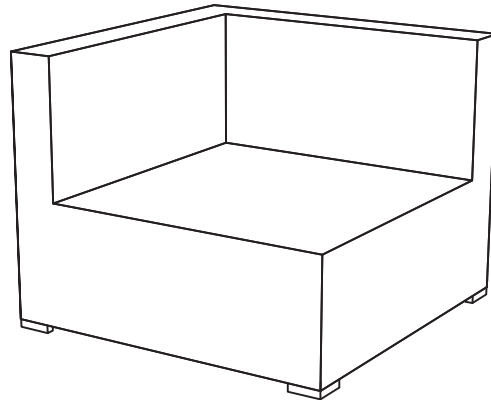

Assembly instruction, 1

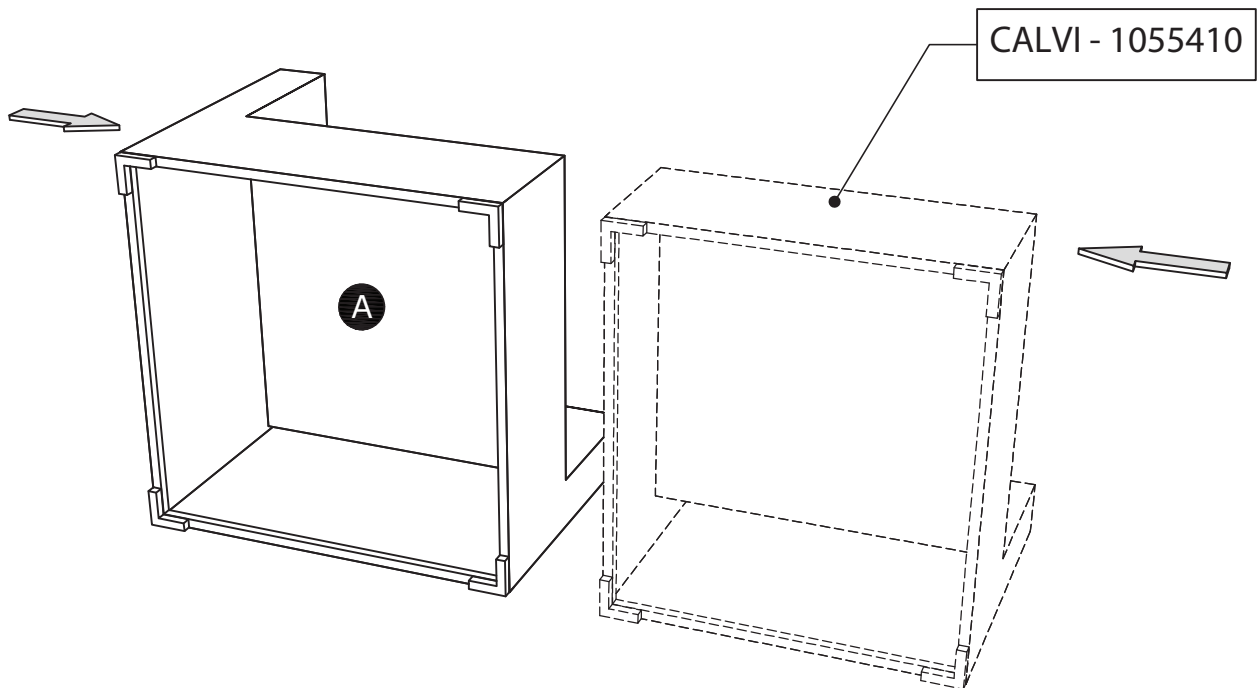

Material list, 2

1 x 1

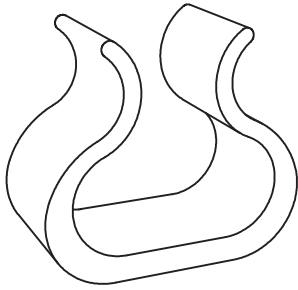

Assembly instruction, 2

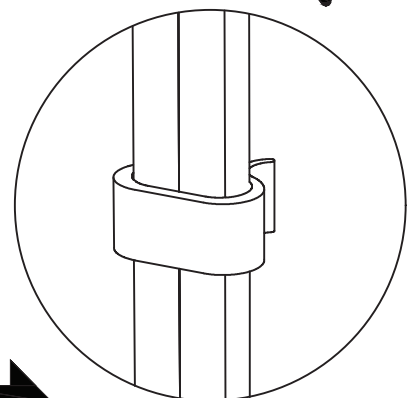
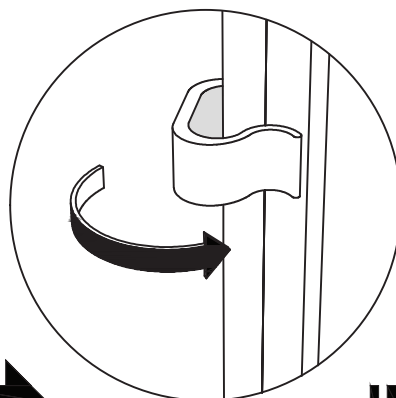
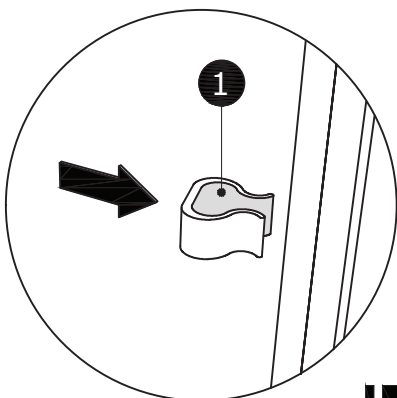
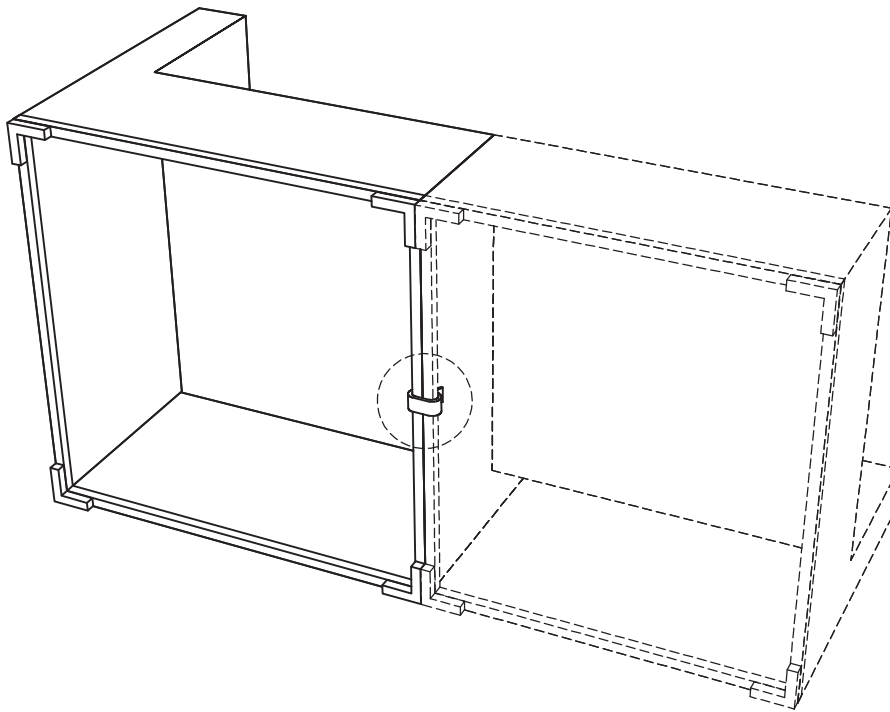

Material list, 3

B x 1

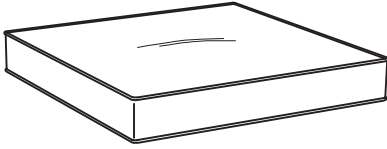

C x 1



Assembly instruction, 3

